

BASILISK GRAZE | OUTDOOR



PROJECT: _____

DISTRIBUTOR: _____

CONTRACTOR: _____

TYPE: _____

COMMENTS: _____

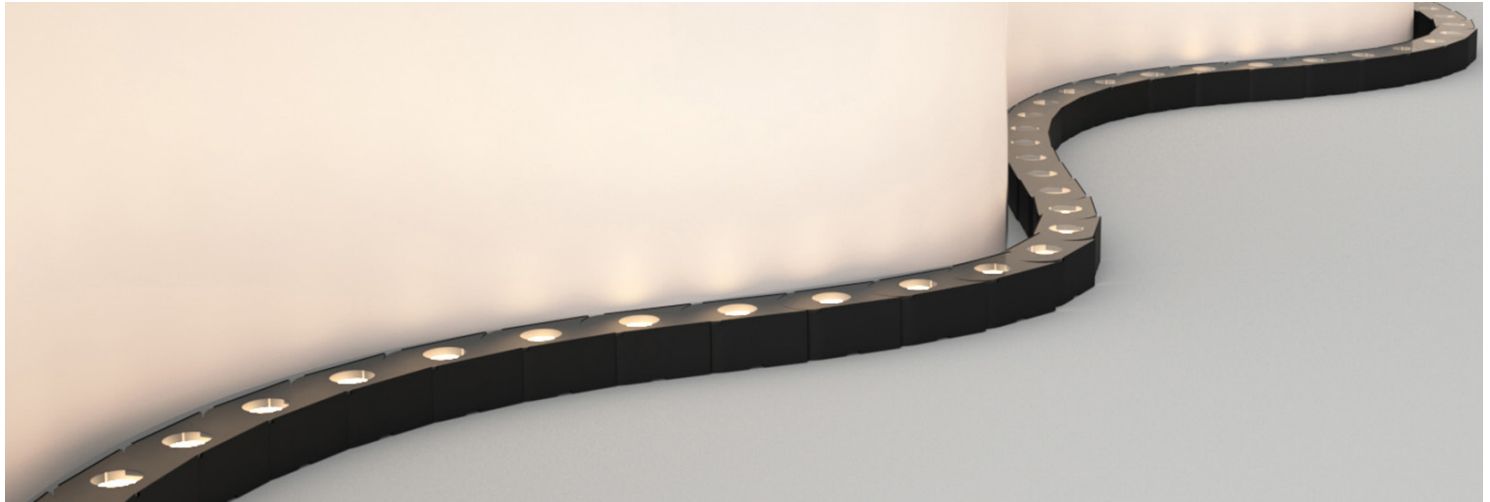

FEATURES

- HORIZONTAL BENDING GRAZER
- IK06 IMPACT RATING
- ADJUSTABLE BRACKET WITH ANGLES TO 180 DEGREES
- MULTIPLE LENS OPTIONS (STANDARD, HONEYCOMB, SHIELD)
- SINGLE BIN
- PLUG AND PLAY UP TO 8FT

PHYSICAL

DIMENSIONS	1.5" (39MM) WIDTH * 1.14" (29MM) HEIGHT
OPERATING TEMPERATURE	-13°F (-25°C) to 122°F (50°C)
MATERIALS	ALUMINUM ALLOY SHELL + TEMPERED GLASS COVER
BEAM ANGLE	15°, 20°, 30°, 40°, 10°X15°, 15°X25°, 15°X40°, OR 25°X45°
INPUT VOLTAGE	24v DC
CLIPS INCLUDED	14"=2 CLIPS, 27"=3 CLIPS, 40"=4 CLIPS, 53"=5 CLIPS

ORDERING INFORMATION

PRODUCT	LENGTH	CCT	OPTIC	LENS
BASILISK BASILISK	XX 14 = 14 IN 27 = 27 IN 40 = 40 IN 53 = 53 IN	XX 27K = 2700K 30K = 3000K 35K = 3500K 40K = 4000K	XX 15 = 15° 20 = 20° 30 = 30° 40 = 40° 1015 = 10°X15° 1525 = 15°X25° 1540 = 15°X40° 2545 = 25°X45°	XX SD = STANDARD HC = HONEYCOMB SHLD = SHIELD

ELECTRICAL

CCT (CORRELATED COLOR TEMPERATURE)

LENGTH	2700K	3000K	3500K	4000K	WATTAGE	MAX RUN	INPUT VOLTAGE
14"	875	886	892	899	12W	8FT	24V DC
27"	1751	1771	1785	1798	24W		
40"	2626	2657	2678	2701	36W		
53"	3504	3543	3571	3598	48W		

PERFORMANCE

CRI	90+
WARRANTY	5 YEARS

OPTIC

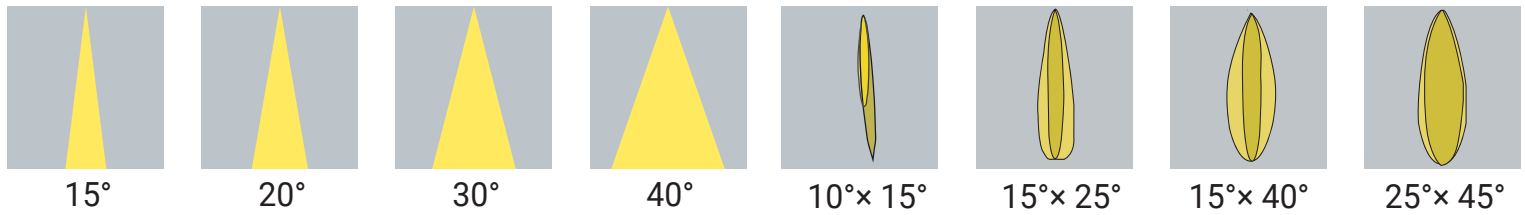

LENS

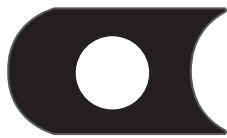

SD
Standard

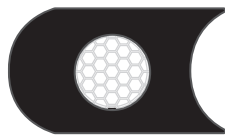

HC
Honeycomb



SHLD
Shield

ADDITIONAL MOUNTING CLIPS (SOLD SEPARATELY)

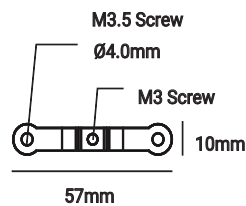

AA-MC-CLIP
Fixed Bracket

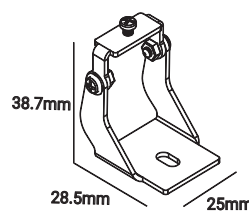

AA-PVT-CLIP
Adjustable Bracket

DIMENSIONS

Min. Length = 14 IN(6×LED) 6 Links (12W)

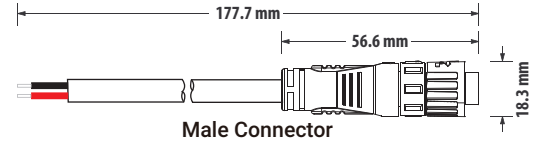
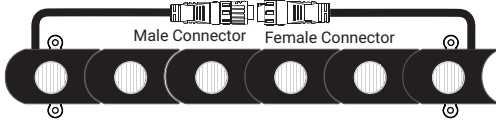

Male Connector

Length = 27 IN(12×LED) 12 Links (24W)

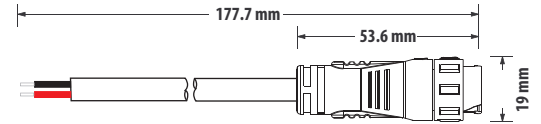
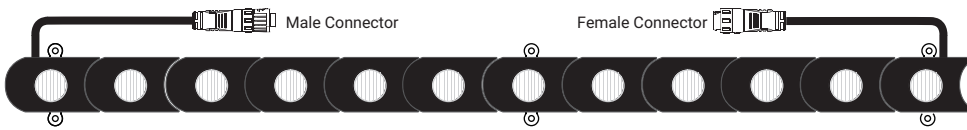

Female Connector

Length = 40 IN(18×LED) 18 Links (36W)



Length = 53 IN(24×LED) 24 Links (48W)

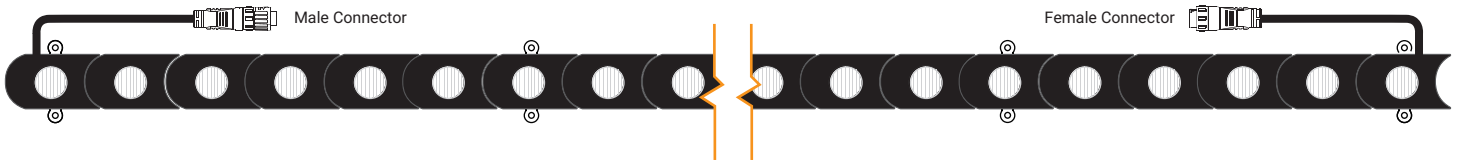

ACCESSORIES (SOLD SEPARATELY)

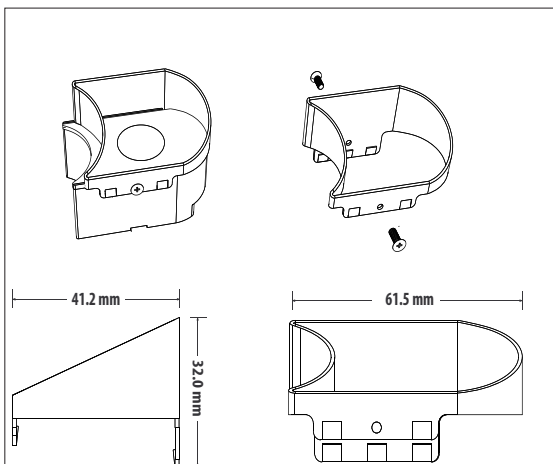

**BASILISK-LOUVER
(1 LOUVER NEEDED FOR
EACH LINK)**